

# HIDDEN.

SISTEMA MARCO OCULTO  
HIDDEN FRAME SYSTEM

**SOLECO | FRAMES**

INNOVATION DIVISION >>







HIDDEN FRAME



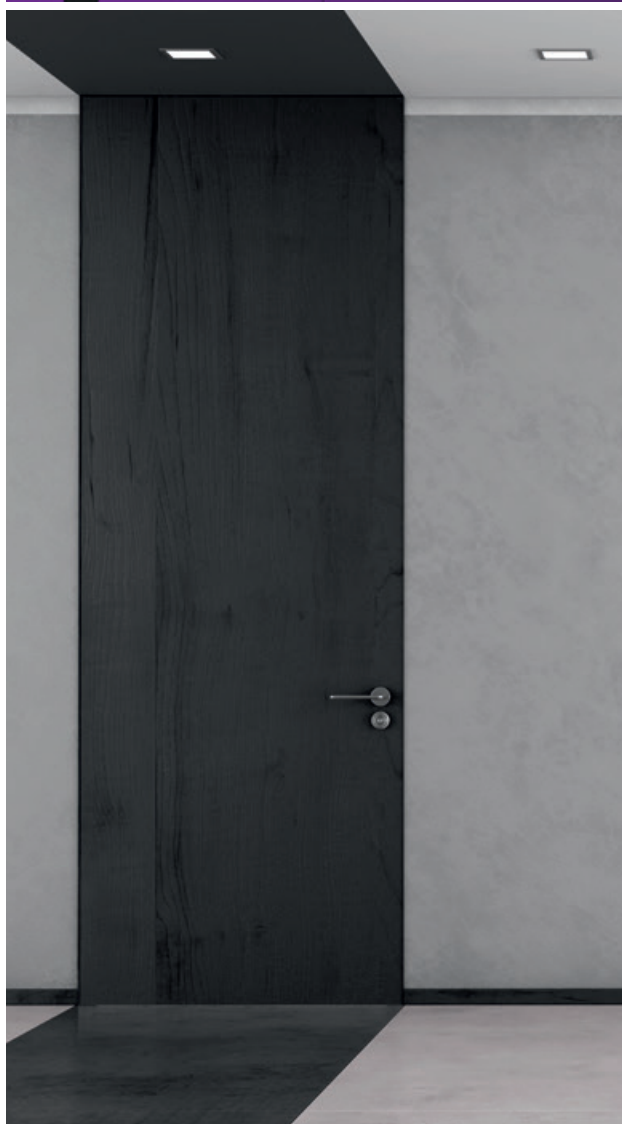

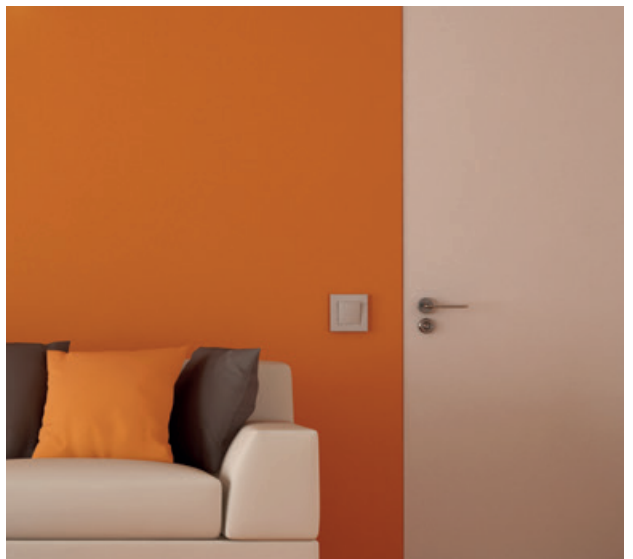
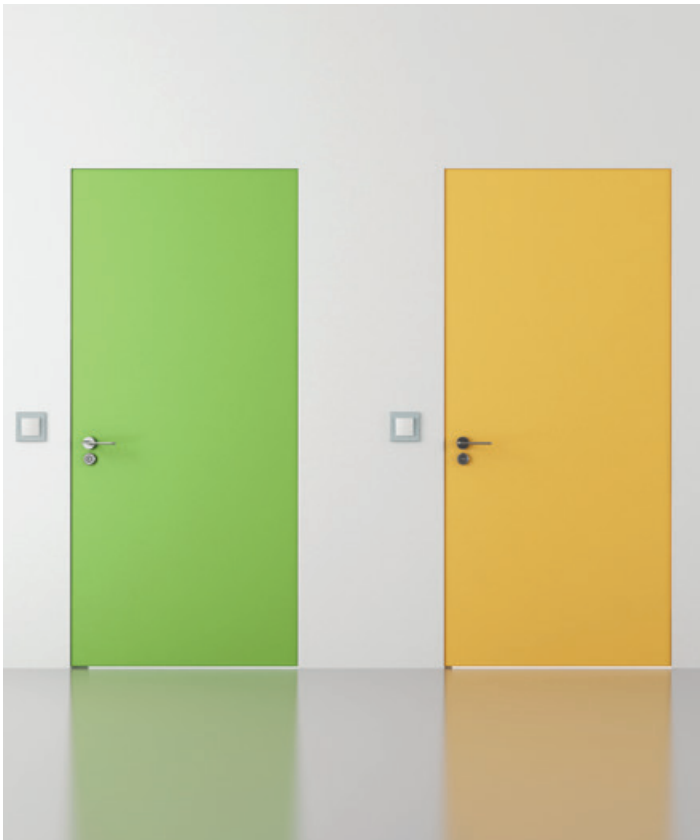



# ALUMINIO / ALUMINIUM | DESCRIPCIÓN TÉCNICA / TECHNICAL DESCRIPTION

## SISTEMA CON MARCO OCULTO / SYSTEM WITH HIDDEN FRAME

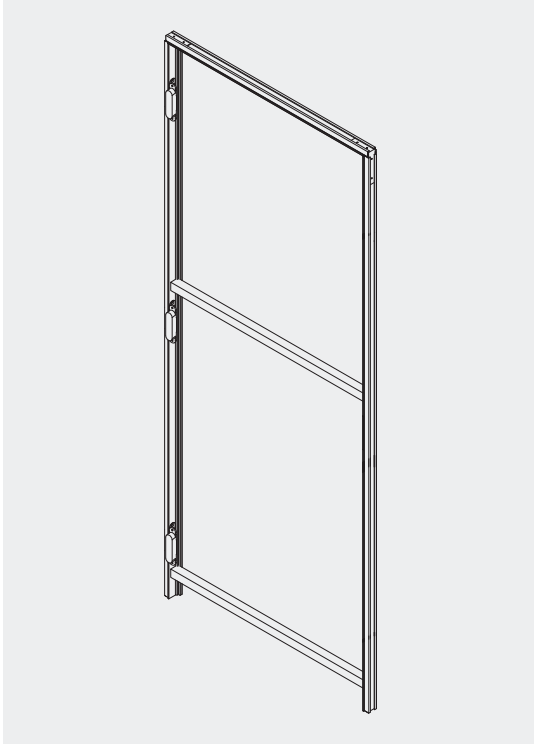

## INSTALACIÓN / INSTALLATION

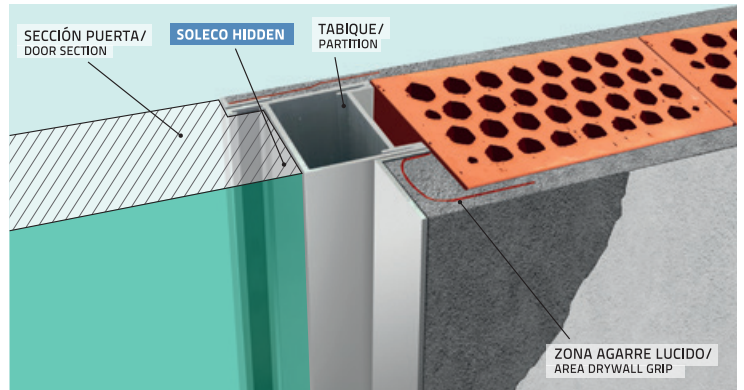

## EQUIPAMIENTO INCLUIDO / EQUIPMENT INCLUDED

**PERNIO SOLECO / SOLECO HINGE**



**BISAGRA OCULTA / HIDDEN HINGE**

Modelo orientativo. Puede variar en función del peso de la hoja. / Illustrative model. May vary according to the weight of the sheet.



## DETALLE / DETAIL

**X:** Ancho hueco de obra. / X: Hollow width of construction.  
**Z:** Alto hueco de obra. / Z: Hollow height of construction.  
**GT:** Grueso de tabique. / GT: Thickness of partition.  
**E:** Ancho total de marco. / E: Total width of frame.  
**H:** Alto total de marco. / H: Total height of frame.  
**PL:** Paso libre de marco. / PL: Free passage of frame.

## APERTURA / OPENING

**Empujando Derecha / Pushing Right**  
**Empujando Izquierda / Pushing Left**

## ALTURAS / HEIGHTS

203 cm - 211 cm.      211 cm - 220 cm.      220 cm - 245 cm.

Otras medidas consultar. / Ask about other measurements.

## ANCHURA / WIDTH

Variable hasta 1100 mm. / Variable upto 1100 mm.

## PESO DE HOJA / WEIGHT OF SHEET

Hasta 60 Kg. / Upto 60 Kg.

Hasta 80 Kg. / Upto 80 Kg.



# ALUMINIO | DESCRIPCIÓN TÉCNICA

## ALUMINIUM | TECHNICAL DESCRIPTION

### MARCO CON APERTURA INTERIOR / FRAME WITH INWARD OPENING

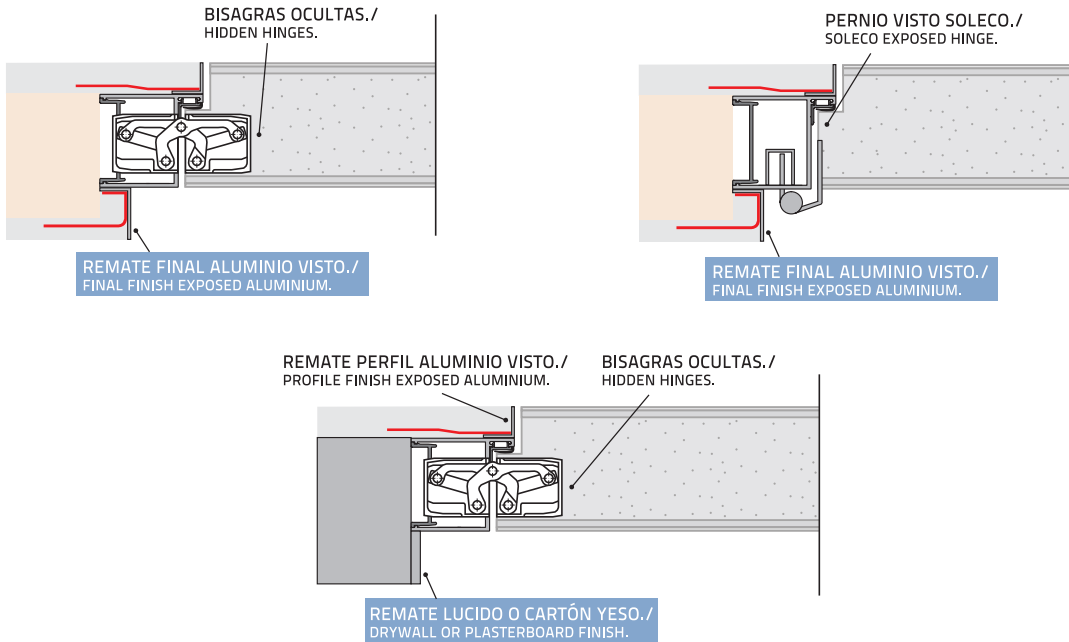

### MARCO CON APERTURA EXTERIOR / FRAME WITH OUTWARD OPENING

**BISAGRAS OCULTAS CON DESPLAZAMIENTO. /  
HIDDEN HINGES WITH DISPLACEMENT.**

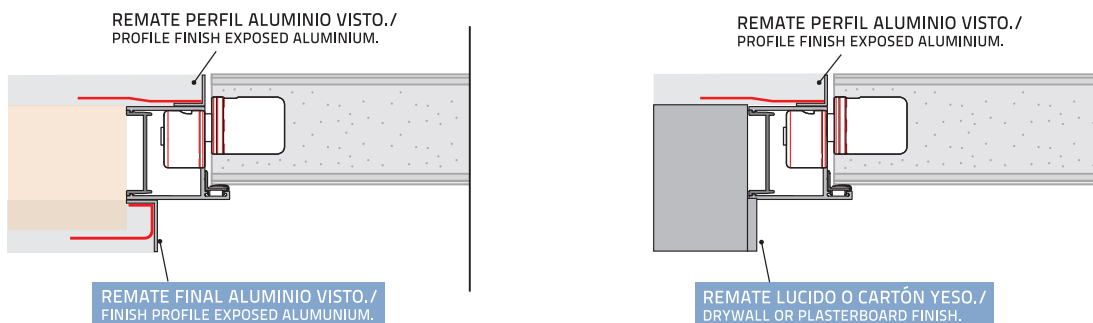

\*TABIQUERÍA DE CARTÓN YESO O LADRILLO CON GRUESO DE TABIQUE VARIABLE. / \*\*PARTITION OF PLASTERBOARD OR BRICK WITH VARIABLE THICKNESS OF PARTITION..

### ACABADOS MARCOS / FRAME FINISHES

Acabado en aluminio anodizado plata,  
lacado RAL o prepintado. / Finished in  
silver-coloured anodized aluminium, RAL  
lacquered or pre-painted.

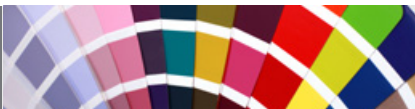

Posibilidad de colores RAL.  
Consultar guía RAL. /  
Possibility of RAL colors.  
Check RAL guide.

Consulte nuestras posibilidades de acabados. / Check our different finishes.



# ACERO GALVANIZADO O INOXIDABLE | DESCRIPCIÓN TÉCNICA

## GALVANIZED OR STAINLESS STEEL | TECHNICAL DESCRIPTION

### INSTALACIÓN / INSTALLATION



### EQUIPAMIENTO INCLUIDO / EQUIPMENT INCLUDED



### DETALLE / DETAIL

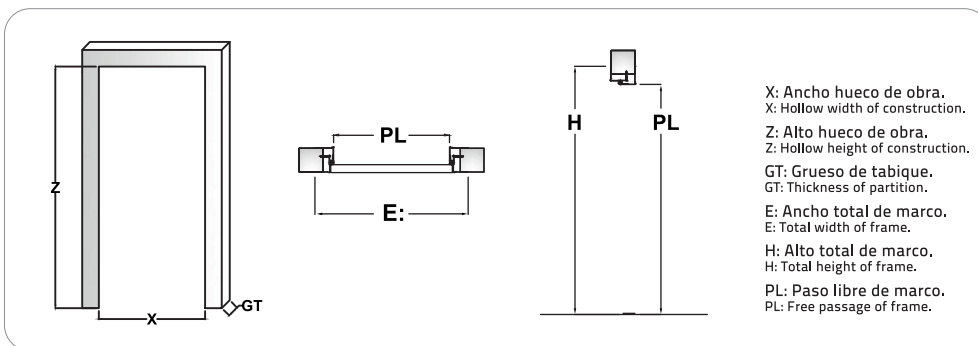

### APERTURA / OPENING

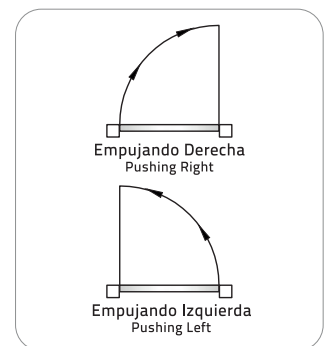

### ALTURAS / HEIGHTS

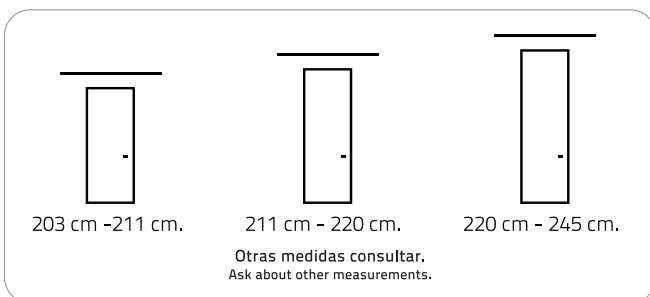

### ANCHURA / ANCHURA



### PESO DE HOJA / PESO DE HOJA





# ACERO GALVANIZADO O INOXIDABLE | DESCRIPCIÓN TÉCNICA

## GALVANIZED OR STAINLESS STEEL | TECHNICAL DESCRIPTION

### PERFIL OCULTO TIPO G CON APERTURA INTERIOR / HIDDEN PROFILE TYPE G WITH INWARD OPENING

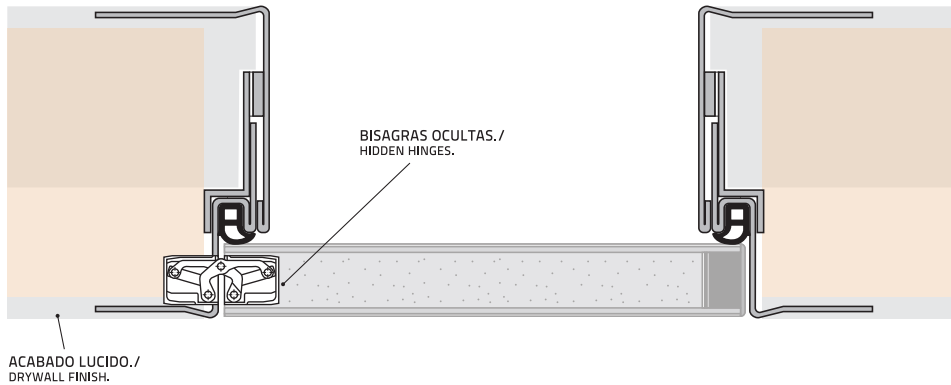

### PERFIL OCULTO TIPO G CON APERTURA EXTERIOR / HIDDEN PROFILE TYPE G WITH OUTWARD OPENING

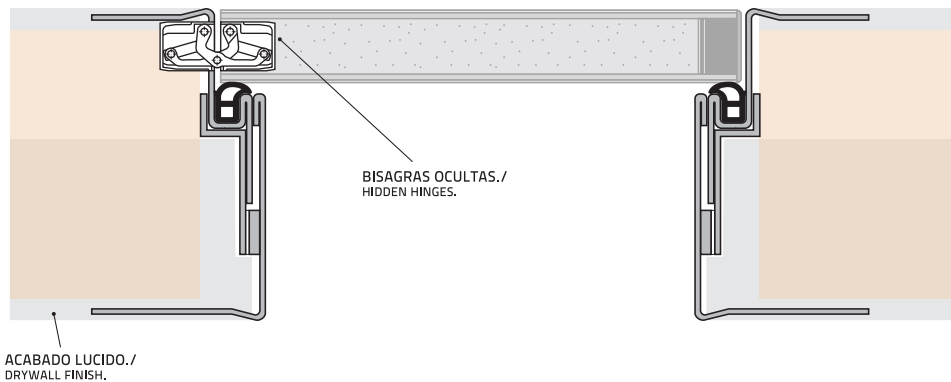

### ACABADOS MARCOS / FRAME FINISHES

MARCOS INOXIDABLES /  
STAINLESS FRAMES

Certificado /  
Certified

AISI 304  
AISI 316

Acero inoxidable /  
Stainless steel

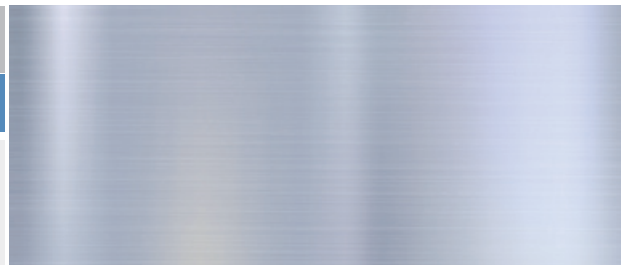

Acabado en acero galvanizado lacado,  
pre-pintado o inoxidable. / Finished in  
galvanized lacquered steel, pre-painted or  
stainless.



Posibilidad de colores RAL.  
Consultar guía RAL. /  
Possibility of RAL colors.  
Check RAL guide.

Consulte nuestras posibilidades de acabados. / Check our different finishes.



**SOLECO** frames |



HIDDEN FRAME





Distribuido por: / Distributed by:

## **SOLECO | FRAMES**

C/ Marjal, 8 - nave A  
46770 Xeraco (Valencia) SPAIN  
T. +34 962 891 149  
e-mail: [info@e-soleco.com](mailto:info@e-soleco.com)  
[www.e-soleco.com](http://www.e-soleco.com)  
[www.solecocercos.com](http://www.solecocercos.com)

Puede obtener más información de nuestro distribuidor.  
Further information may be obtained from our distributor.